



**L 410
NG**

www.let.cz



Aircraft Industries

L 410 NG

ON THE WINGS OF L 410 NG
TO FARAWAY DESTINATIONS

L 410 NG Story

Basic Aircraft Characteristics



The L 410 NG (New Generation), substantially upgraded turboprop commuter inheriting the best of L 410 UVP-E20 aircraft, offers significantly improved flight parameters and operational characteristics. The state of the art Glass Cockpit Technology with the latest avionics from Garmin G3000 provides the highest level of flight safety and comfort for the crew. Thanks to the new wing structure with integral fuel tank and increased fuel capacity, the L 410 NG enables significantly longer range and endurance. The all-metal, high-wing twin turboprop, powered by new more powerful GE H85-200 engines and AV-725 propellers, is in its standard version intended for short-haul transport from remote and undeveloped areas to major cities. The multipurpose aircraft can transport 19 passengers and thanks to its increased maximum payload and larger front luggage compartment can carry up to 500 kg more luggage/cargo than previous L 410 models.

With its spacious oval fuselage and completely modernized passenger cabin interior provides the highest standard of passenger comfort and offers maximum versatility and opportunity to use the L 410 NG aircraft in a number of versions for various types of operations.

Since 1969, more than 1,200 aircraft of all L 410 series models have been produced. Currently, there are over 350 aircraft of this series in more than 60 countries all over the world in operation. The L 410 NG is the latest and most advanced model in this famous aircraft series.

The aircraft has been certified in accordance with regulations of EU (EASA), USA (FAA), Russian Federation (FATA).



Basic Aircraft Advantages

L410
NG

- » durable retractable landing gear enables take-off and landing on unpaved strips, including: rain-soaked grass, sand, snow or airfields with slush (minimum airstrip strength of 6,0 kg/cm² (85,3 psi) needed)
- » ability to land and take off on short runways (STOL capabilities)
- » tough and durable structure which enables operation in severe conditions
- » the most spacious passenger compartment in the commuter category (more p. 6)
- » remarkable hot and high performance
- » ability to operate under extreme climatic conditions, ranging from -50 °C to +50 °C
- » longer range and endurance than previous L 410 UVP-E20 model (more p. 8-9)
- » increased payload and thus possibility to transport up to 500 kg more luggage/cargo than previous model L 410 UVP-E20
- » outstanding versatility with a number of quick change kits, increasing aircraft utility (more p. 14-19)
- » easy handling and low operating and maintenance costs
- » low noise level in the passenger cabin
- » reliable operation
- » certified autopilot GFC 700 (part of G3000 system)

cantilever wing without supporting struts

more fuel capacity

engines without HSI

full glass cockpit



The Most Spacious Cabin

Dimensions and Weights

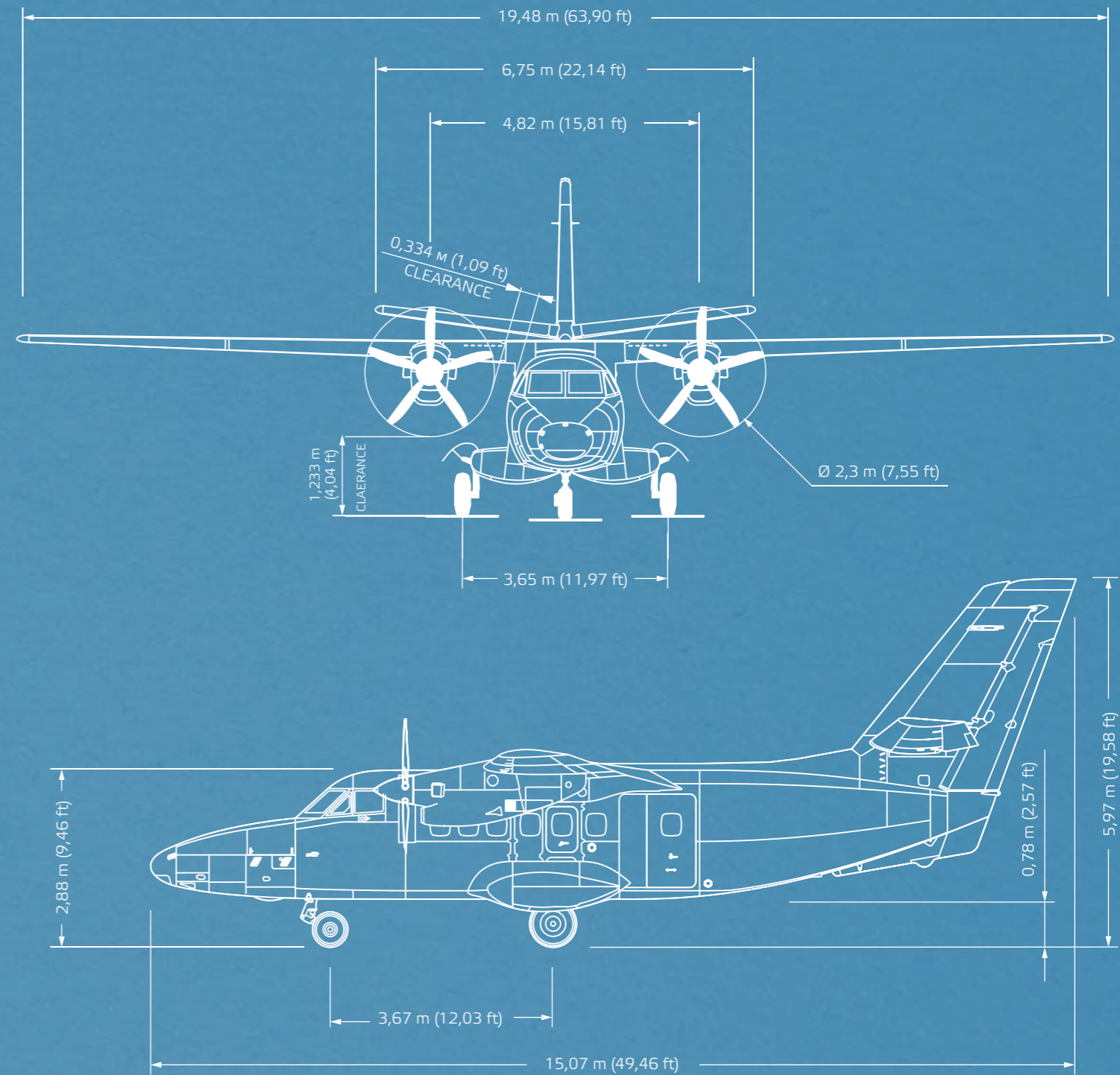
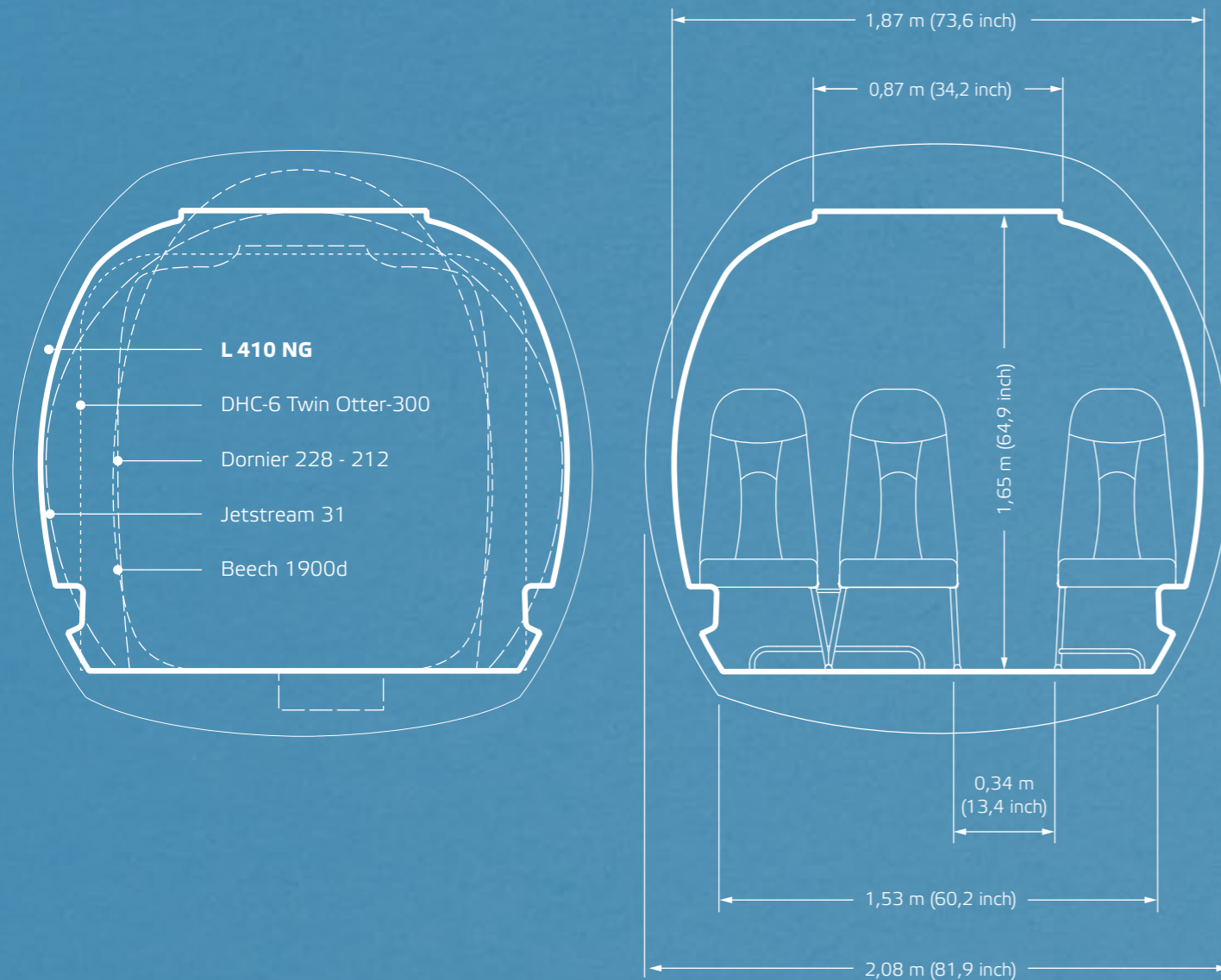

Dimensions

Passenger Cabin Volume	17,9 m ³	632 ft ³
Passenger Door	0,8 x 1,46 m	31,5 x 57,5 in
Cargo Door	1,25 x 1,46 m	49,2 x 57,5 in
Seats Pitch	0,76 m	29,9 in
Luggage Compartment Volume (standard passenger version)	2,31 m ³	81,6 ft ³

Weights

Max. Take-off Weight	7 000 kg	15 432 lb
Max. Landing Weight	6 800 kg	14 991 lb
Max. Zero Fuel Weight	6 600 kg	14 551 lb
Max. Payload	2 300 kg	5 071 lb
Max. Fuel Weight	1 854 kg	4 087 lb
Max. Fuel Weight with tip tanks	2 244 kg	4 947 lb

Flying Beyond Expectations

Performance



Max. Cruise Speed	417 km/h	225 KTAS
Max. Range *	2 570 km	1 387 NM
Max. Endurance *	10,5 h	630 min
Maximum Operating Altitude	6 100 m	20 000 ft
One Engine Inoperative Ceiling	3 900 m	12 800 ft
Service Ceiling	8 230 m	27 000 ft

* 45 minutes reserve, with tip tanks

Climb Rate		
Both Engines	8,5 m/s	1 673 fpm
Single Engine	1,7 m/s	335 fpm
Take-off Distance	590 m	1 936 ft
Landing Distance	600 m	1 969 ft

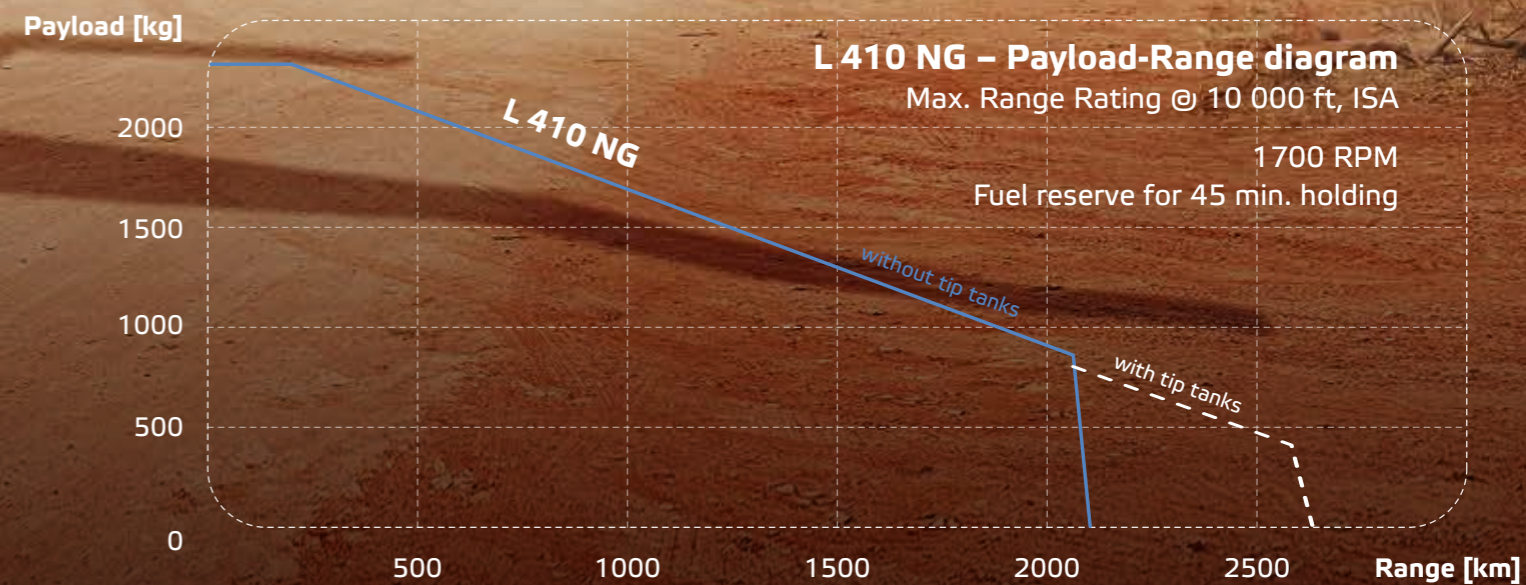
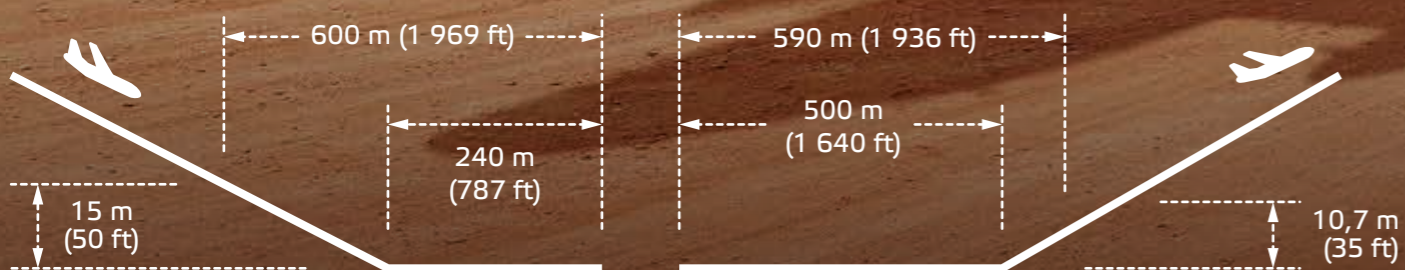

Power Plant



The GE H Series engine features sophisticated technologies such as 3D aerodynamic airfoil designs, blisk (bladed disk) compressor rotors, and high temperature materials. These technologies deliver more shaft horsepower, improved engine fuel efficiency and increased temperature margin, significantly increasing hot-day takeoff capability and high-altitude performance. GE H85-200 engine features an advanced reduction gearbox which lowers maximum propeller speed from 2 080 RMP to 1 950 RMP, resulting in external and internal noise reduction.

The unique configuration of the engine simplifies maintenance by eliminating the need for recurrent fuel nozzle maintenance and periodic hot section inspections.



Engines

- » Model: GE H85-200
- » Producer: GE Aviation Czech s.r.o.
- » Proven design, successor of M601 engine, 4 500+ pieces delivered
- » Two-shaft, free turbine, reverse-flow design
- » Power: 634 kW/ 850 SHP
- » Flat rated temperature: 31 °C
- » Max. continuous power: 634 kW / 850 SHP
- » TBO: 3 600 FH
- » Dry engine weight: 204 kg
- » HSI (hot section inspection) is not required
- » None Fuel nozzle inspection

Propellers

- » Model: AV-725
- » Producer: Avia Propeller s.r.o., Czech Republic
- » Propeller speed: 1 950 RPM
- » TBO: 3 600 FH / 6 600 FC
- » Weight: 79 kg (174 lb)
- » Low noise level
- » Possibility to transport blades separately
- » Metal double-action highly efficient AV-725 propellers are extremely durable and resistant to rough conditions on unpaved airstrips. Propellers are equipped with a system of automatic and manual feathering





Safety First

Avionics and Instrumentation

State of the art avionics Garmin G3000 Glass Cockpit Technology

Standard Equipment

PRIMARY FLIGHT INSTRUMENTS

- » Dual Primary Flight Display GDU 1250W
- » Multifunction Display GDU 1250W
- » Dual Multi System Touchscreen Controller GTC 575

BACK-UP FLIGHT INSTRUMENTS

- » Electronic Stand-by Instrument MD302 SAM

PRIMARY FLIGHT SENSORS

- » Dual independent Air Data Computer GDC 7400
- » Dual independent Heading Reference System GR57800

AUTOMATIC FLIGHT CONTROL SYSTEM

- » Integrated Autopilot System GFC 700
 - Dual Autopilot Cat I, Dual FD, 3 axis + YAW damper, Auto/Manual elevator trim

NAVIGATION

- » Dual Flight Management System
- » GNSS, GPS
- » Dead-reckoning mode
- » Graphical/PC Flight Planning
- » Multi Leg VNAV
- » Automatic Direction Finder ADF 4000
- » Dual Distance Measuring Equipment DME 4000

COMMUNICATION

- » Dual independent VHF radio integrated in GIA 64
- » Dual independent Audio Processor GMA 36B
- » Satellite communication System GSR 56 (Iridium)

HAZARD AVOIDANCE AND SURVEILLANCE

- » Integrated TAWS A
- » Synthetic Vision System (optional)
- » Traffic processor TCAS II (7.1) GTS 8000
- » Solid state color Weather Radar GWX75
- » Garmin Flight Data Services (GFDS) Worldwide
- » Weather Datalink GSR 56 (Iridium)

USER INTERFACE

- » Garmin FliteCharts and Jeppesen ChartView (optional)
- » Central Maintenance Function / Data logging
- » Electronic Checklist (optional)

DATA RECORDERS

- » Flight Data Recorder FDR-25 from Universal
- » Cockpit Voice Recorder CVR-120A from Universal

OPTIONAL EQUIPMENT

- » High Frequency Transceiver - KHF 1050

Outstanding Versatility

Multipurpose Aircraft

L410
NG

The spacious, oval fuselage with almost 18 m³ of passenger cabin volume, provides the highest standard of passenger comfort as well as maximum versatility and opportunity for utilization of the aircraft for a number of different applications and special missions. The new wing structure with integral fuel tank (wet wing) and increased fuel capacity offers new opportunity to utilise the aircraft more extensively as a maritime, patrol and surveillance version.

The aircraft is produced in following basic versions:

- » Standard configuration
- » Cargo containers or foldable seats
- » Air ambulance / Medevac
- » Sky diving
- » Photogrammetric Scanning, Maritime, Surveillance and Patrol Version

Standard equipment for all versions includes:
de-icing system, heating, ventilation, cargo door

Available on request for all versions:
air-conditioning, tail surface lighting, single point refueling

Standard Configuration for 19 passengers

Standard equipment:

- » Front (max 300 kg) and rear (max 245 kg) luggage compartment accessible from the passenger cabin
- » Simple emergency chemical toilet in the rear of the aircraft
- » Wide choice of upholstery fabrics including leather

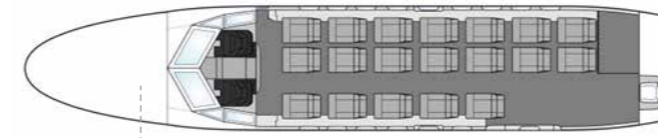

Large front luggage compartment enables to transport more cargo



245 kg – 0,94 m³

Additional equipment for standard version available on request:

- » Service tables
- » 32" LCD monitor
- » Headphones
- » Attendant foldable seat
- » DVD player
- » Variable luggage compartment



Extendable Cargo Module Quick Change Kit

- » Possibility to enlarge the rear luggage compartment by removing the last two or four seats as follows:
- » 17 passengers (15 passengers) plus extra 215kg (450 kg) of cargo – in total 460 kg (695 kg) in rear luggage compartment

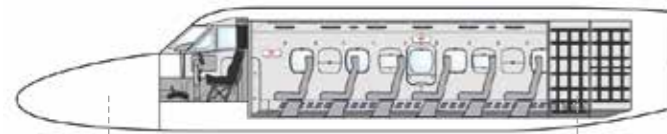

300 kg
1,37 m³

17  460 kg
1,93 m³

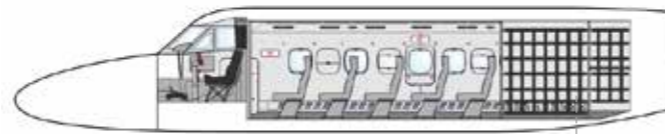

15  695 kg
2,97 m³

Cargo Quick Change Kit

- » Transportation up to 1 700 kg
- » Max dimensions of cargo
4,44 m x 1,08 m x 1,5 m
(14,57 ft x 3,54 ft x 4,92 ft)
- » Nets and belts to secure the cargo

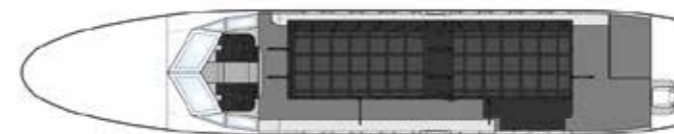
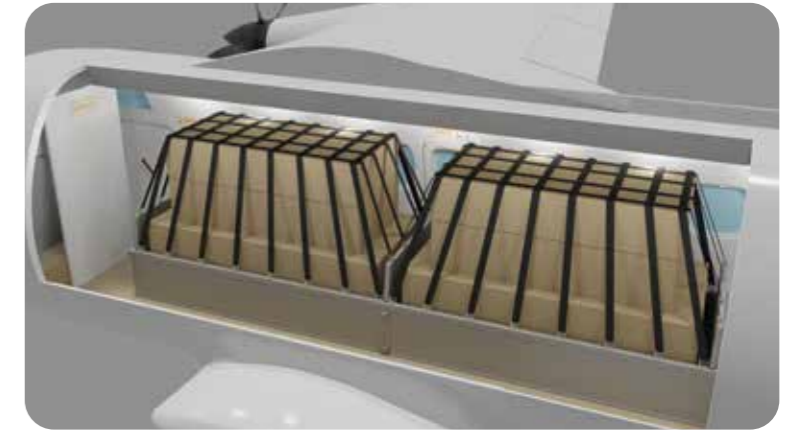

Foldable Seats Quick Change Kit

- » Light weight seats (weighing up to 20 kg less than the standard seats)
- » Easy conversion from passenger to cargo version and vice versa
- » Net system for cargo fixation to the floor



Basic Air Ambulance Quick Change Kit

- » Six stretchers (with belts)
- » Seats for three accompanying medical staff
- » Collapsible table
- » *optional - Installation of 4x Bio-bags*

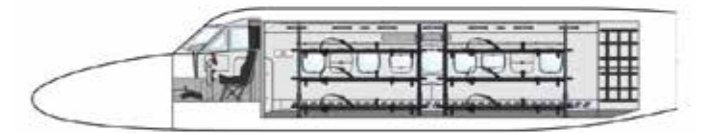
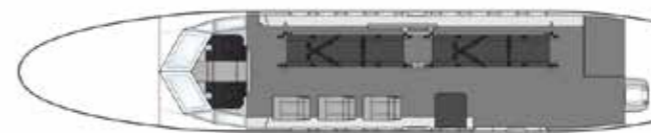

Sky Diving Quick Change Kit

- » Foldable seats for 18 skydivers with fastening belts
- » Wide roll-up door
- » External footboard for a photographer
- » Signalling lights

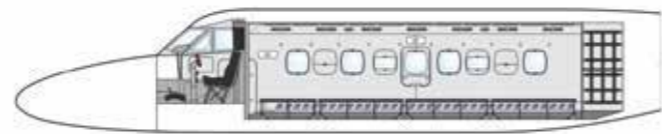
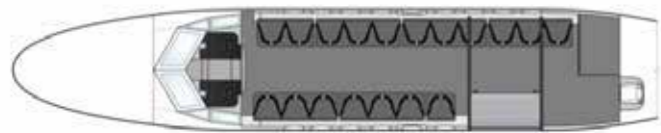

Air Ambulance Biohazard Kit

- » 4 stretchers (with belts)
- » Seats for three accompanying medical staff
- » Collapsible table
- » Compatible with Bio-bag EBV -30/40/IN/CH

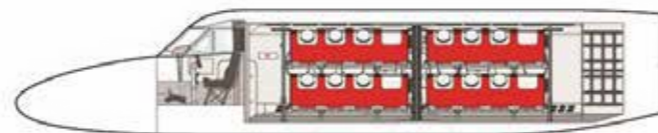
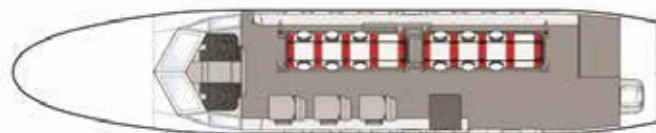
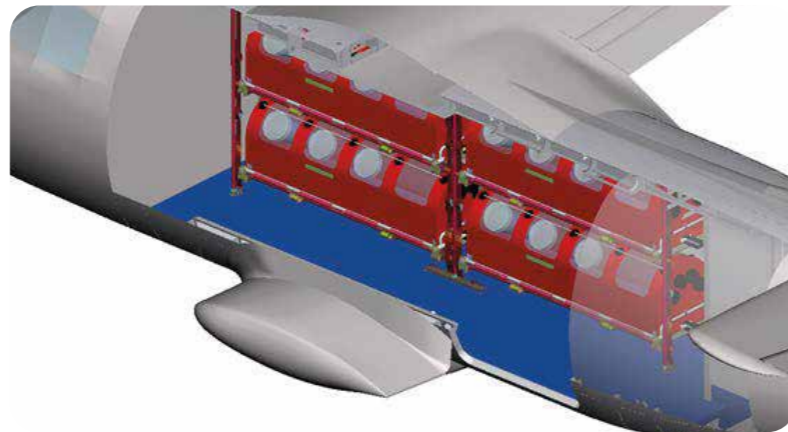

Photogrammetric Scanning, Maritime, Surveillance and Patrol Version

- » Endurance of L 410 NG up to 10,5 hr
- » Installation of additional fuel tanks is available
- » Wide range of special missions (search and rescue operations, natural/industrial disaster management, monitoring borders and coast lines, fishery protection, oil pollution, chemical dumping detection, management of shipping,...)
- » Individually configured
- » Wide range of functions (detection, search, recording, observation,...)
- » Professional equipment (special devices and sensors, search radar, SLAR, EO/IR camera, scanners,...)

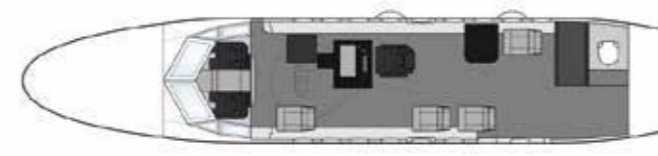

VIP Passenger Version

- » Wide selection of equipment (kitchenette, audiovisual equipment, toilet room, etc.)
- » 4-8 seats upon customer request
- » 2 tables
- » Improved interior

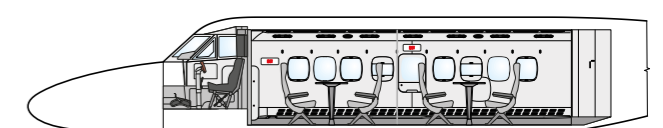
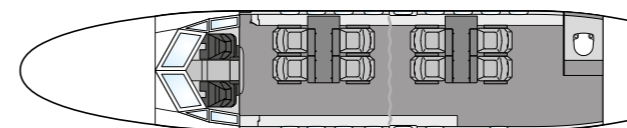

Technical Support and Services



After Sales Customer Service offers following support:

- » Technical consultations and/or specific assistance related to aircraft inspections, repairs and other services
- » Regular Bulletin Service including operational documentation
- » Issuance of Information bulletins as per individual requirements (aircraft modifications, repairs, avionic modernisations, etc.)
- » Assistance with repairs, including structural analysis and analysis of technological procedures for repairs
- » Warranty claims solutions
- » Provision of special servicing and testing equipment for aircraft maintenance



- » Assistance with ferry flights or provision of ferry flights
- » Route and economy analysis
- » On-site factory personnel to provide customer assistance for the aircraft operation
- » Type rating pilot's training in training organization in the Czech Republic, approved in accordance with Part 147 EASA, FFS Level D (Type VII) qualification certificate. Pilots are trained on the most modern L 410 flight simulator certified in the D category, which meets all regulatory requirements for the highest level of these devices according to the standards of ICAO (Type VII), EASA, FAA (Level D) and FATA.
- » Delivery of original and certified spare parts via our Spare Parts Department
- » 24/7 service

Maintenance

Aircraft Industries carries out the whole range of maintenance services through Maintenance Organization approved in accordance with Regulation (EC) No. 2042/2003 and Annex II (Part 145).

Aircraft Industries offers following services:

- » Periodical maintenance and inspections
- » Modifications, upgrades and modernization
- » New paint upon customers' request
- » Field and in-house repairs
- » Aircraft technician's assistance during the initial phase of operation [all personnel are certified in accordance with Regulation (EC) No. 2042/2003 and Annex III (Part 66)]
- » Type rating training of aircraft engineers by the training organization in the Czech Republic, approved by EASA Part 147

On The Wings of
Safety and Comfort



Aircraft Industries, a.s.

Na Zahonech 1177, 686 04 Kunovice
Czech Republic
www.let.cz

sales@let.cz